

# PRODUCT INFORMATION





Perry Lounge Chair

82064231

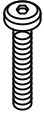

# INSTRUCTION

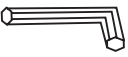
## Step 1

<p>A</p>  <p>M6*45mm 4x</p>	<p>B</p>  <p>M8*30mm 1x</p>	<p>C</p>  <p>M6*16mm 4x</p>	<p>D</p>  <p>M5 1x</p>
<p>E</p>  <p>M8*18mm 1x</p>			



①x1

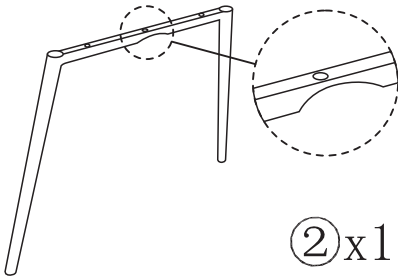

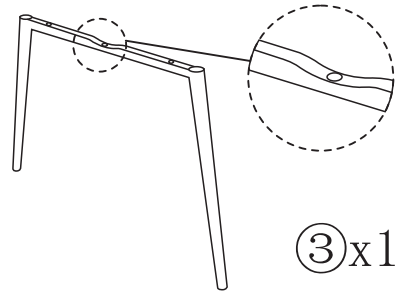

②x1



③x1

# INSTRUCTION

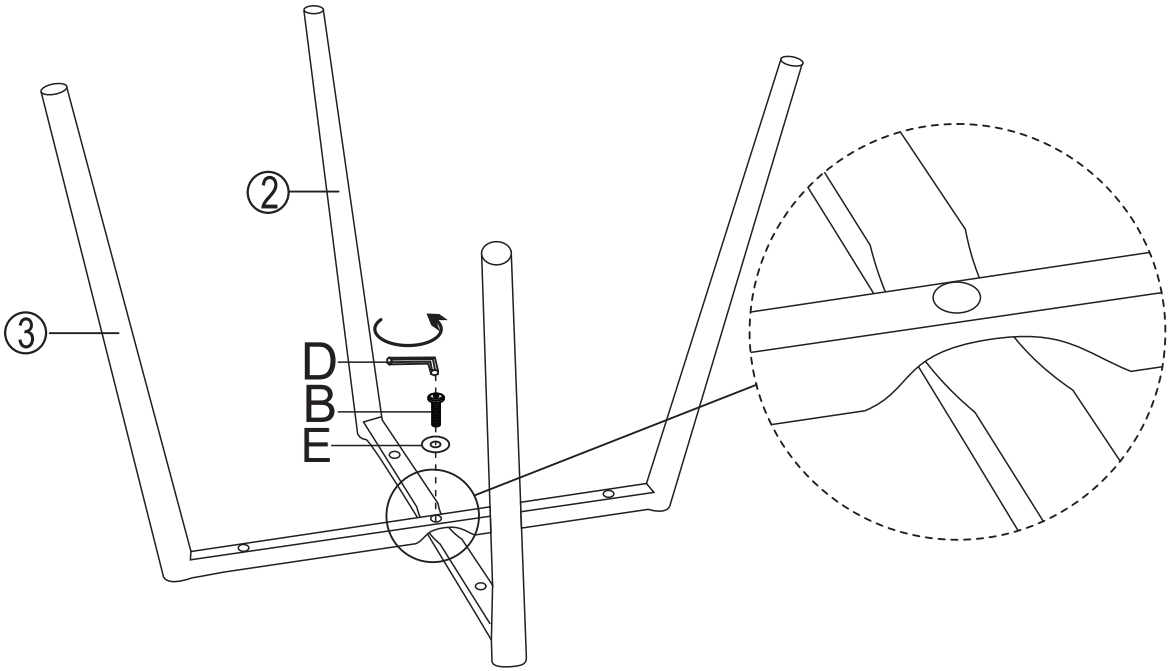

## Step 2

<p><b>B</b></p>  <p>M6*30mm 1x</p>	<p><b>D</b></p>  <p>M5 1x</p>	<p><b>E</b></p>  <p>M8*18mm 1x</p>
---	--	---

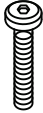

# INSTRUCTION

## Step 3

<p>A</p>  <p>M6*45mm 4x</p>	<p>C</p>  <p>M6*16mm 4x</p>	<p>D</p>  <p>M5 1x</p>
--	--	---

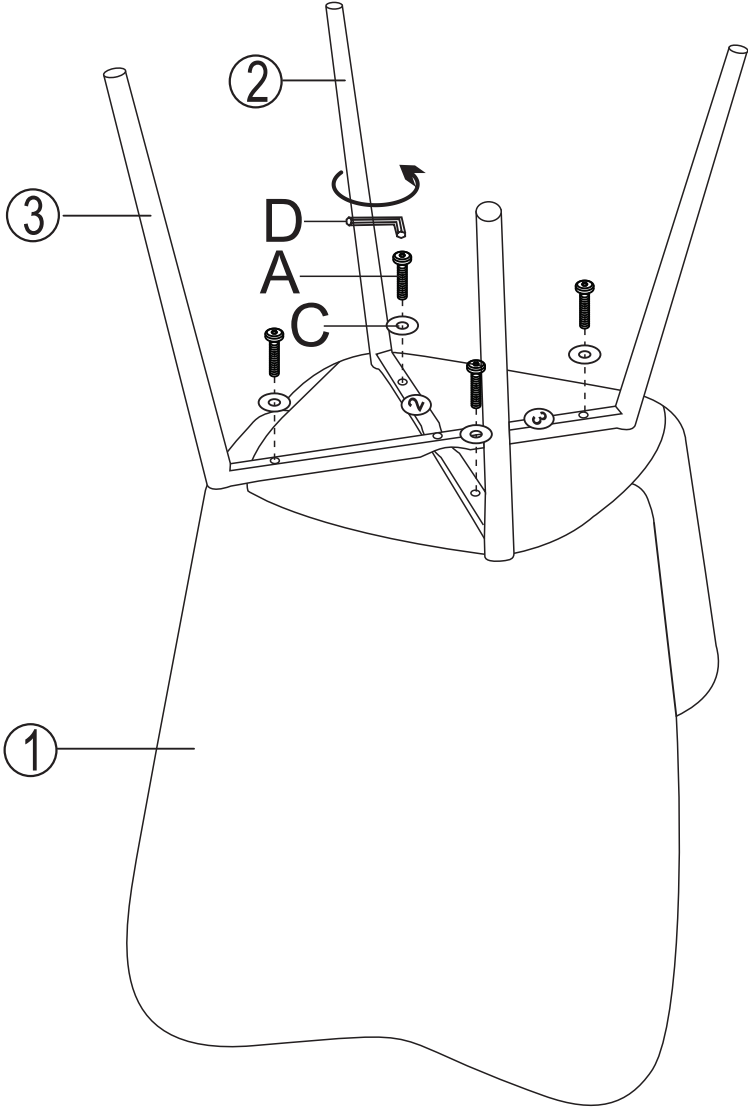

# INSTRUCTION

## Step 4

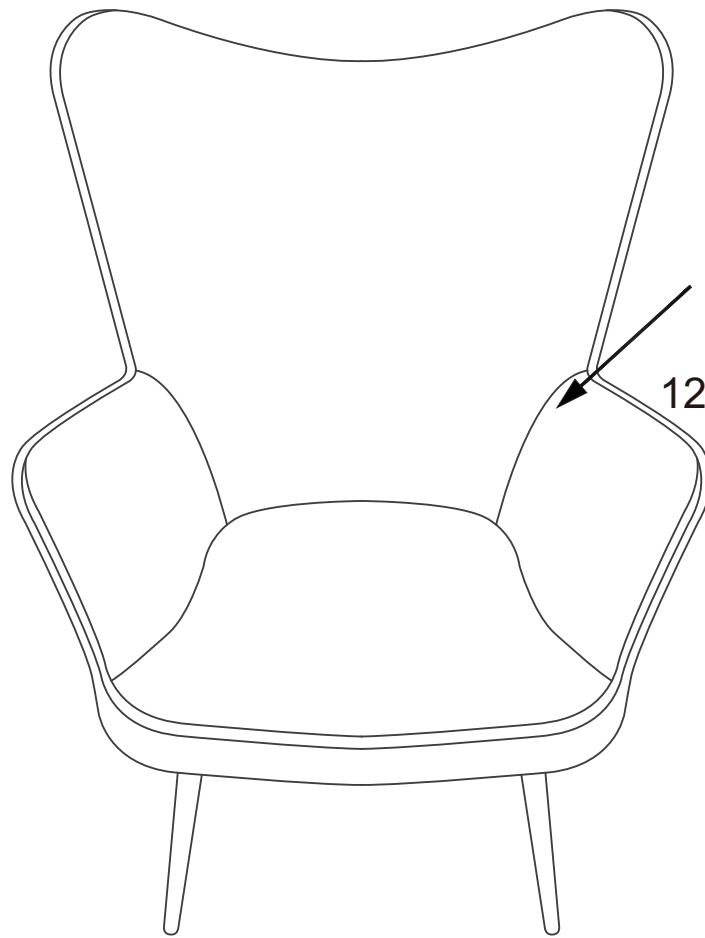

120KG/264LBS